

ENTRANCE DOORS

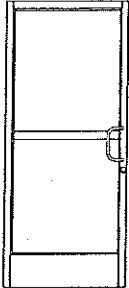

Narrow stile

Narrow stile Center pivot single acting, Offset pivot single acting, Butt hinge single acting. An industry standard in style and performance. Narrow stiles and rails provide narrow sight lines yet receives most standard hardware designs. Strong reinforced corner construction permits use in heavy traffic areas of commercial applications.

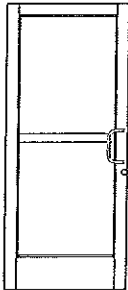

Medium stile

Medium stile Center pivot double acting, Offset pivot single acting, Butt hinge single acting. A top performance door with a medium stile that accommodates standard and custom hardware and panic devices for commercial and institutional applications. Strong reinforced corner construction increases size limitation to a 4'-0" door width 9'0" maximum door height.

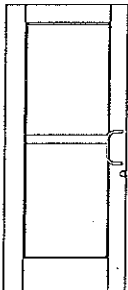

Wide stile

Wide stile Center pivot double acting, Offset pivot single acting, Butt hinge single acting. A monumental type door with strength and stability for heavy use. The wide stiles will accommodate most all standard and unusual hardware designs and operation requirements. Size limitations are 4'-0" door width and 9'0" maximum door height.

ENTRANCE DOORS

OPERATION CONFIGURATIONS

"We have the *fastest* leadtimes in the industry guaranteed!"

CENTER HUNG

Standard doors hardware includes std lock/cylinder on single doors and pairs active leaf, header/threshold bolt for pairs inactive leaf with push bars BTB.

All doors are prepared to receive side load arm for concealed closers (pivots are not included).

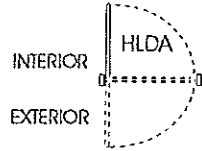
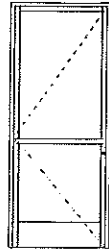

HINGED LEFT
DOUBLE ACTING

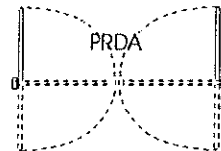
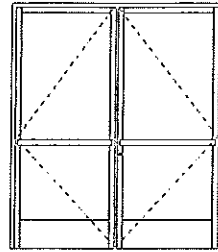

PAIR OF DOUBLE ACTING

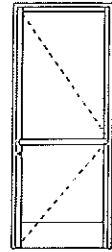

HINGED RIGHT
DOUBLE ACTING

OFFSET HUNG

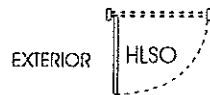
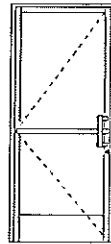

HINGED LEFT
SWING OUT

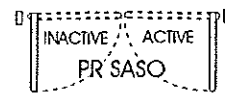
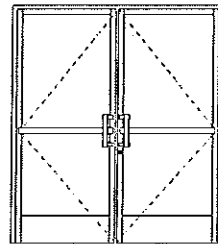

PAIR OF SINGLE ACTING
SWING IN

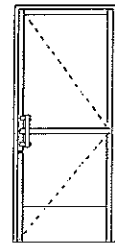

HINGED RIGHT
SWING OUT

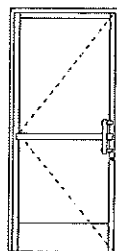

HINGED LEFT
SWING IN

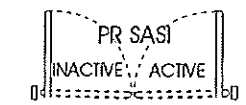
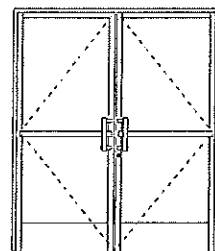

PAIR OF SINGLE ACTING
SWING OUT

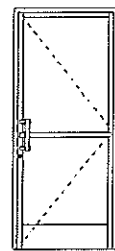

HINGED RIGHT
SWING IN

ENTRANCE DOORS

1/4"-1" GLASS STOP

FULL SCALE

NARROW STYLE

2-VERTICAL STILE

"We have the *fastest* leadtimes in the industry guaranteed!"

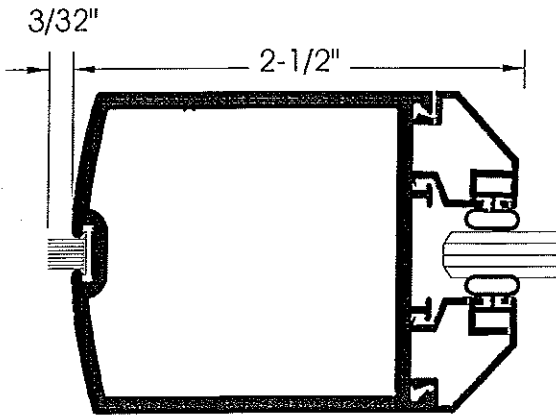

CENTER-HUNG DOOR
1/2" BEVEL GLASS STOP

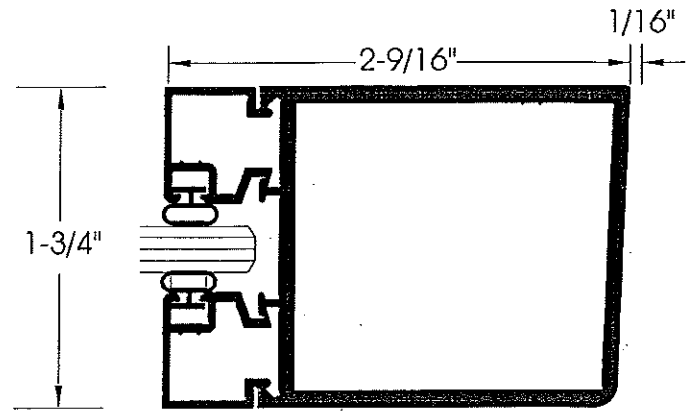

OFFSET-HUNG DOOR
1/4" SQUARE GLASS STOP

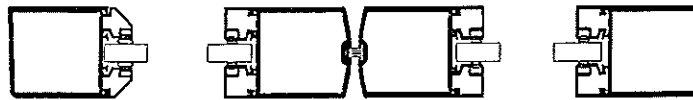

INACTIVE

ACTIVE

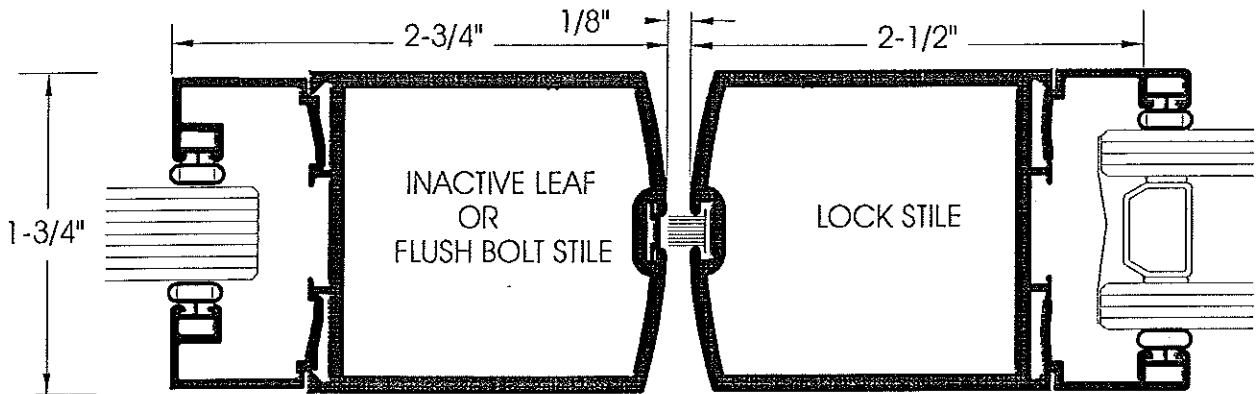

MEETING STILES

CENTER-HUNG DOORS
1/2" GLASS STOP

CENTER-HUNG DOORS
1" GLASS STOP



INACTIVE

ACTIVE

MATERIAL: 6063-T5 aluminum alloy.

FINISH: Standard finishes are mill, clear and bronze anodized. All others are special order.

ENTRANCE DOORS

1/2"-1" GLASS STOP

FULL SCALE

NARROW STYLE

2" RAIL

"We have the *fastest* leadtimes in the industry guaranteed!"

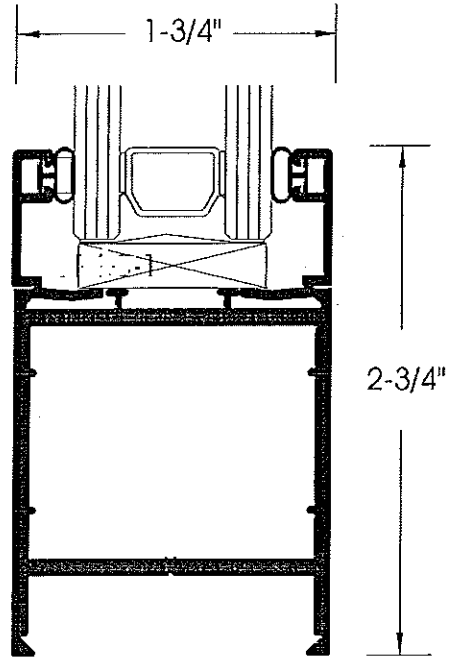
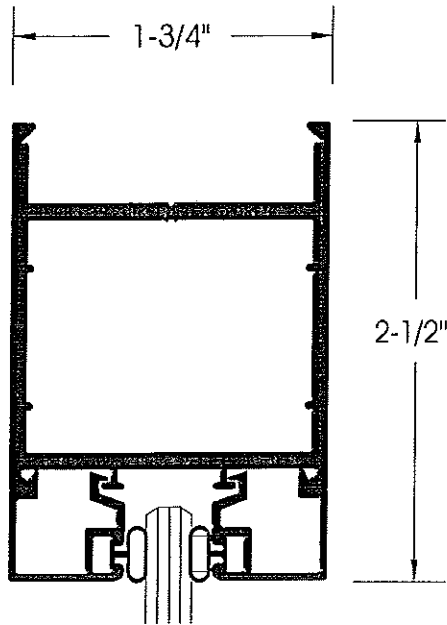

TOP/BOTTOM
DOOR RAIL
1/2" GLASS STOP

FINISHES	MILL
	CLEAR
	BRONZE

TOP/BOTTOM
DOOR RAIL
1" GLASS STOP

FINISHES	MILL
	CLEAR
	BRONZE

FINISH: Standard finishes are mill, clear and bronze anodized. All others are special order.

ENTRANCE DOORS
 1/4"-1" GLASS STOP
FULL SCALE

MEDIUM STYLE
 3 1/2" VERTICAL STILE

FINISHES

MILL
CLEAR
BRONZE

CENTER HUNG
 DOOR STILE
 1/4" GLASS STOP

INACTIVE LEAF
 DOOR STILE
 1" GLASS STOP

OFFSET HUNG
 DOOR STILE
 1/4" GLASS STOP

"We have the *fastest* leadtimes in the industry guaranteed!"

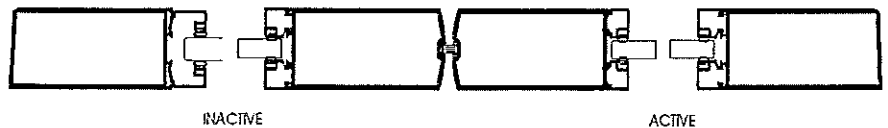
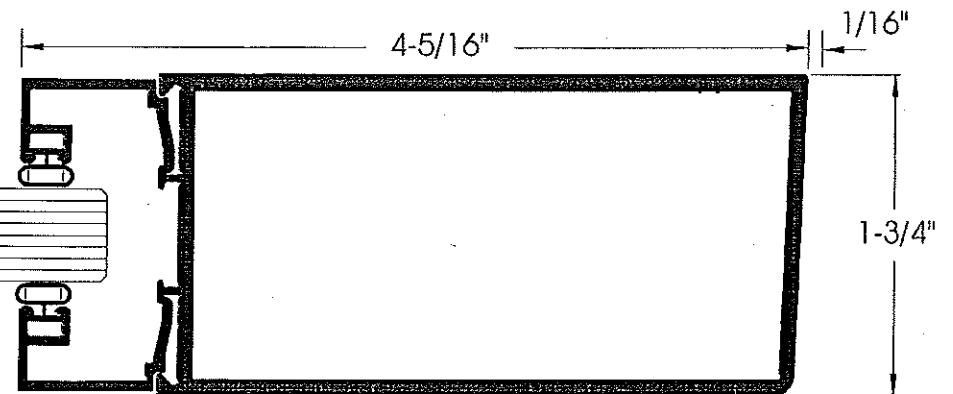
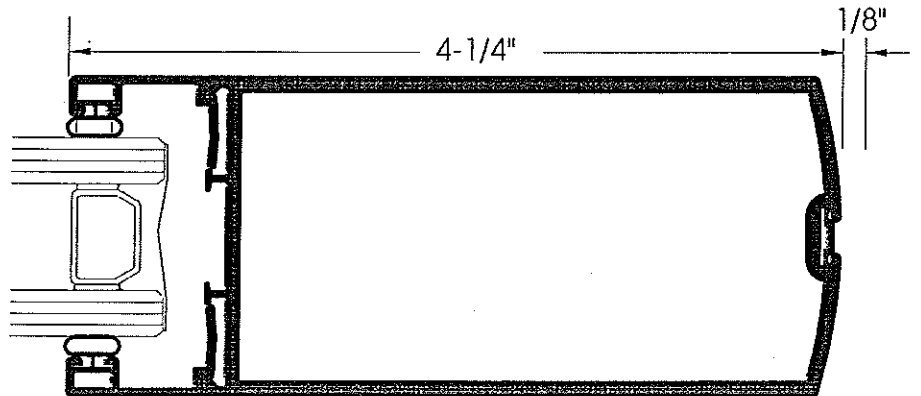
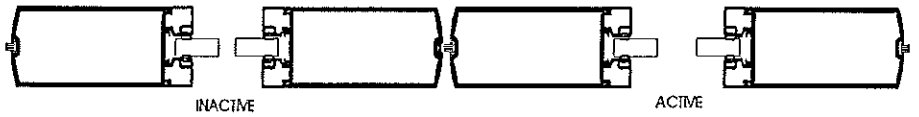
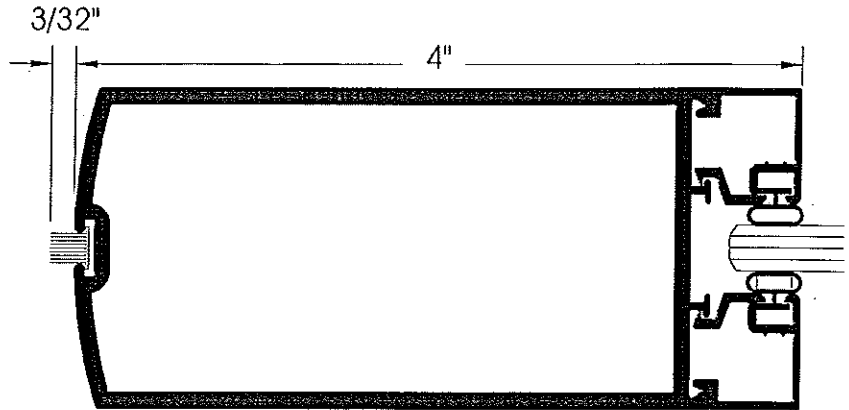

MATERIAL: 6063-T5 aluminum alloy.
FINISH: Standard finishes are mill, clear and bronze anodized. All others are special order.

ENTRANCE DOORS

1/4"-1" GLASS STOP

FULL SCALE

MEDIUM STYLE

3-1/4" RAIL

"We have the fastest leadtimes in the industry guaranteed!"

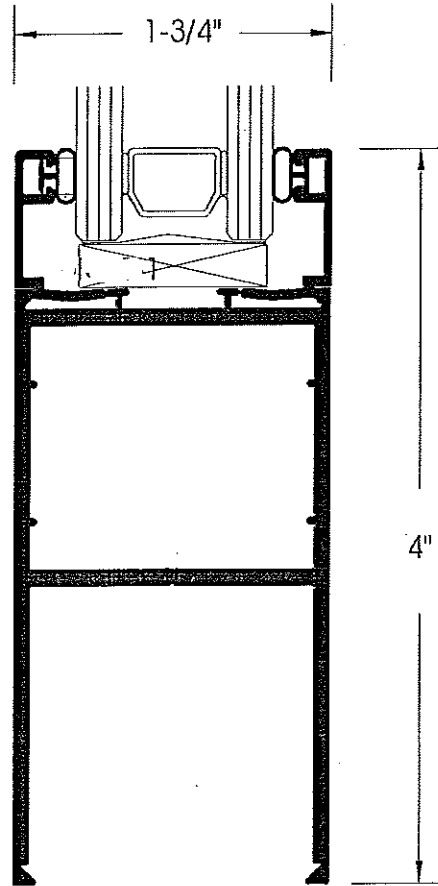
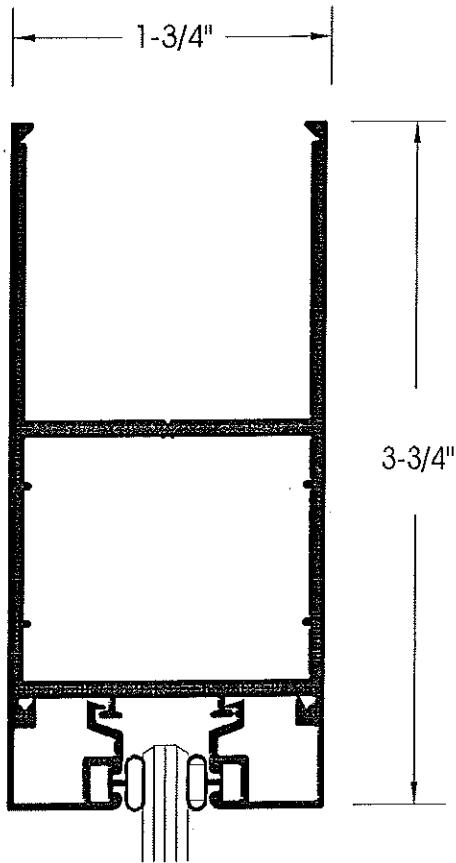

TOP/BOTTOM
DOOR RAIL
1/4" GLASS STOP

FINISHES	MILL
	CLEAR
	BRONZE

TOP/BOTTOM
DOOR RAIL
1" GLASS STOP

FINISHES	MILL
	CLEAR
	BRONZE

MATERIAL: 6063-T5 aluminum alloy.

FINISH: Standard finishes are mill, clear and bronze anodized. All others are special order.

ENTRANCE DOORS

1/4"-1" GLASS STOP

FULL SCALE

"We have the fastest leadtimes in the industry guaranteed!"

WIDE STYLE
5" VERTICAL STILE

FINISHES
MILL
CLEAR
BRONZE

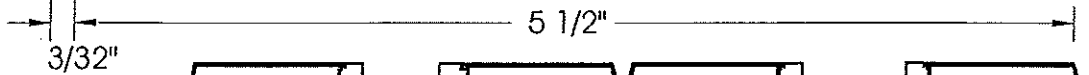
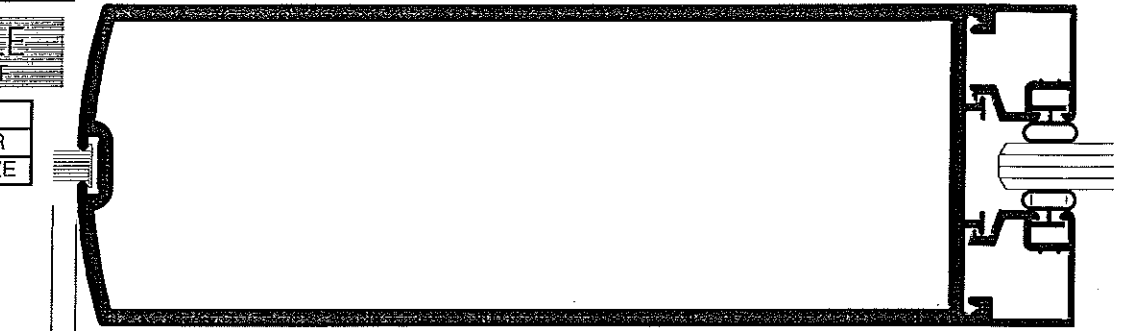

CENTER HUNG
DOOR STILE
1/4" GLASS STOP

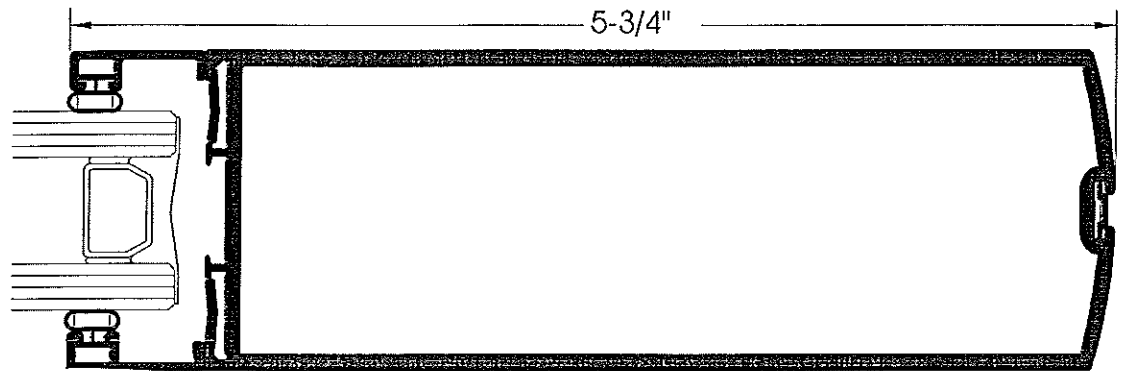
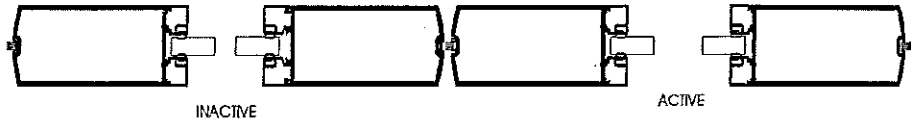

INACTIVE LEAF
DOOR STILE
1" GLASS STOP

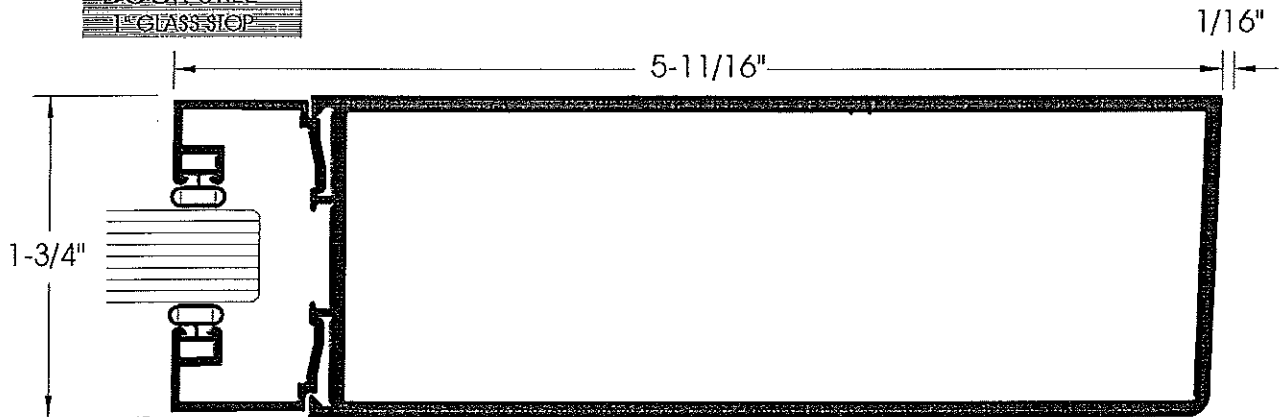

OFFSET HUNG
DOOR STILE
1/2" GLASS STOP



MATERIAL: 6063-T5 aluminum alloy.

FINISH: Standard finishes are mill, clear and bronze anodized. All others are special order.

ENTRANCE DOORS
 7/8" GLASS STOP
FULL SCALE

"We have the *fastest* leadtimes in the industry guaranteed!"

WIDE STYLE
 5-1/8" RAIL

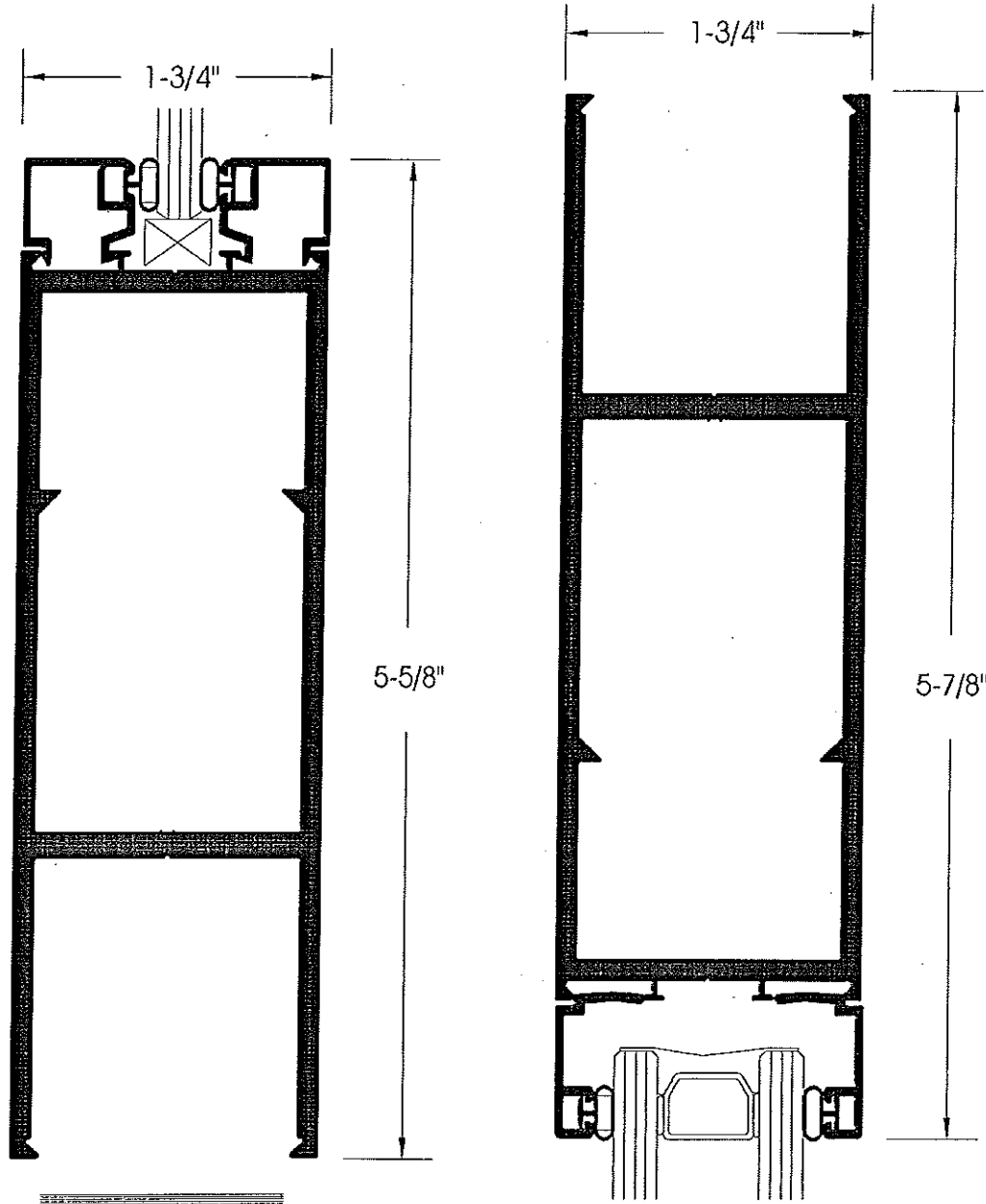

TOP/BOTTOM
 DOOR RAIL
 7/8" GLASS STOP

- FINISHES
- | |
|--------|
| MILL |
| CLEAR |
| BRONZE |

TOP/BOTTOM
 DOOR RAIL
 1" GLASS STOP

- FINISHES
- | |
|--------|
| MILL |
| CLEAR |
| BRONZE |

MATERIAL: 6063-T5 aluminum alloy.
FINISH: Standard finishes are mill, clear and bronze anodized. All others are special order.

ENTRANCE DOORS
 1/4"-1" GLASS STOP
FULL SCALE
HORIZONTAL MUNTIN
 3-1/4" MUNTIN

"We have the *fastest* leadtimes in the industry guaranteed!"

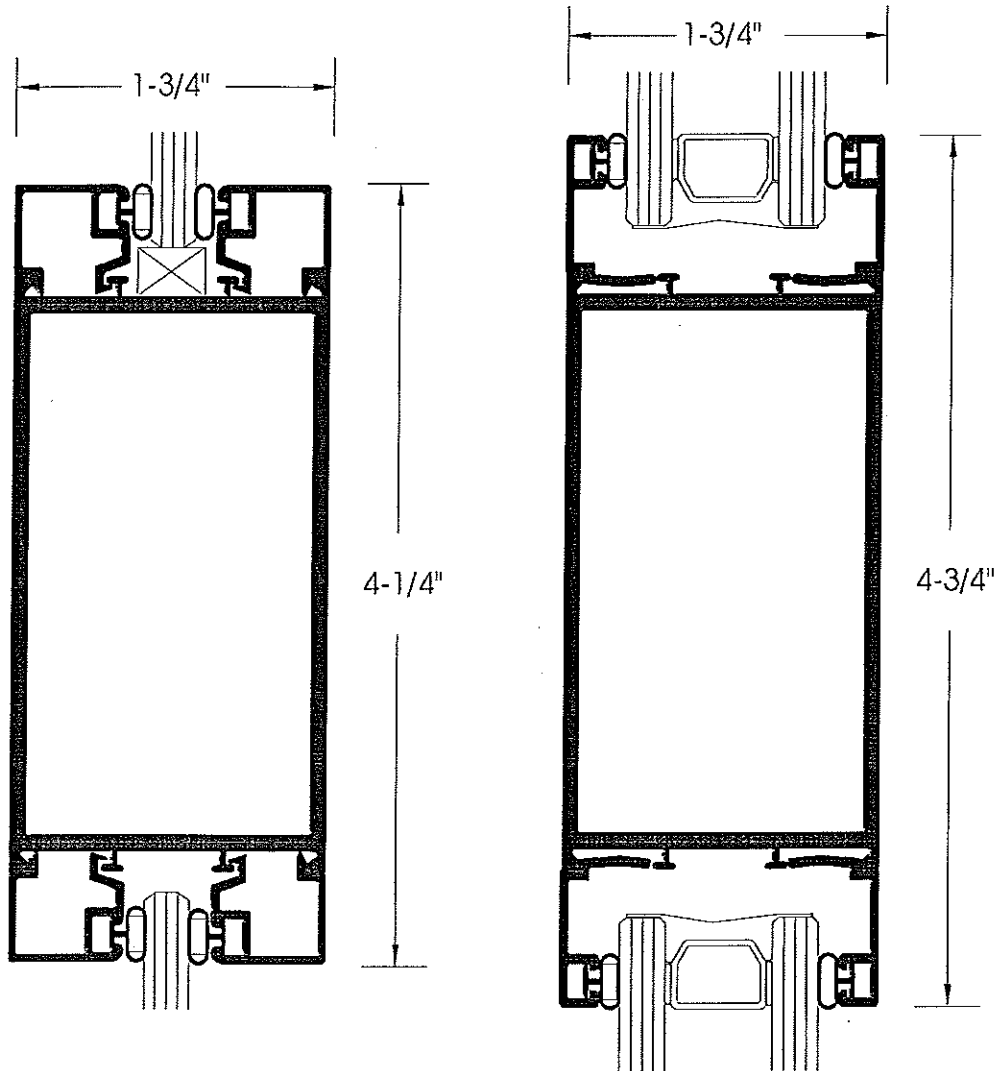

HORIZONTAL DOOR MUNTIN
 1/4" GLASS STOP

FINISHES	MILL
	CLEAR
	BRONZE

HORIZONTAL DOOR MUNTIN
 1" GLASS STOP

FINISHES	MILL
	CLEAR
	BRONZE

MATERIAL: 6063-T5 aluminum alloy.
FINISH: Standard finishes are mill, clear and bronze anodized. All others are special order.

ENTRANCE DOORS
 1/4"-1" GLASS STOP
FULL SCALE

"We have the *fastest* leadtimes in the industry guaranteed!"

HORIZONTAL MUNTIN
 2" MUNTIN

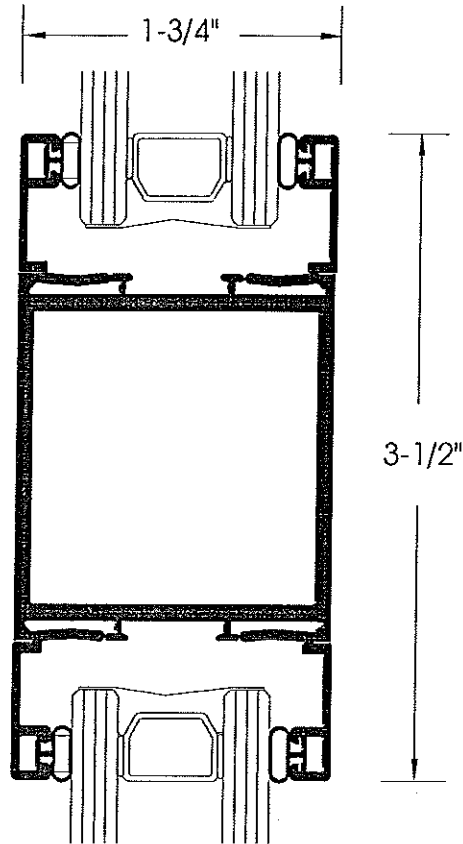
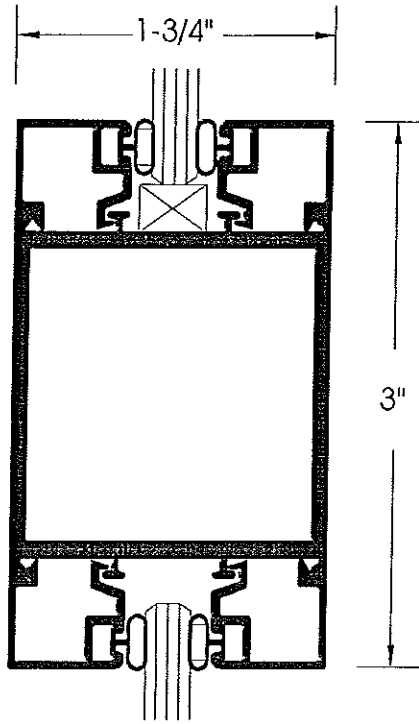

HORIZONTAL DOOR MUNTIN
 1/4" GLASS STOP

FINISHES	MILL
	CLEAR
	BRONZE

HORIZONTAL DOOR MUNTIN
 1/2" GLASS STOP

FINISHES	MILL
	CLEAR
	BRONZE

MATERIAL: 6063-T5 aluminum alloy.

FINISH: Standard finishes are mill, clear and bronze anodized. All others are special order.